



# Lumi-LinQ

WIRELESS EXTERIOR LIGHTING CONTROL SYSTEM





# What Is Lumi-LinQ?

Lumi-LinQ is an innovative wireless lighting control system that allows users to monitor their energy performance data and complete operational status information for all Lumi-LinQ standard and emergency luminaires. Information is displayed on the Lumi-LinQ website which can be accessed from anywhere using a computer, laptop, tablet or smart-phone. The clear graphical user interface provides an overview of the whole site, through to the performance and operation of an individual luminaire.

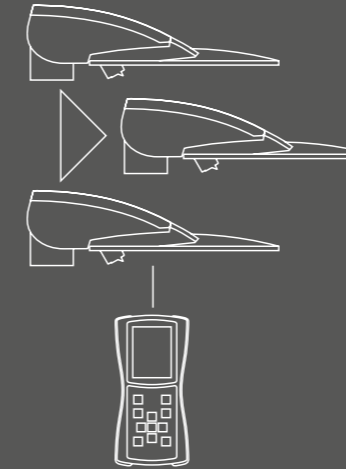

## Platform 1

Luminaires operate on a stand-alone basis: Lumi-LinQ luminaires link wirelessly in groups for presence detection and scene setting. Energy performance data and operational status information can be retrieved using the Lumi-LinQ Programmer. Emergency luminaires are self-test with the addition that operational status and most recent emergency test information can be retrieved using the Lumi-LinQ Programmer.

## Platform 2

The same luminaires are also very simply wirelessly linked into a Gateway which collects and transmits their energy performance data and complete operational status information, for all Lumi-LinQ standard and emergency luminaires, to the world wide web for viewing using tablets, smart-phones, laptops and computers.

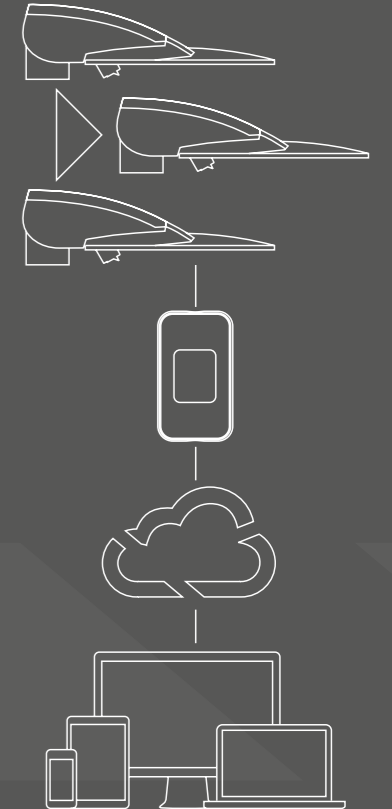

*Projects initially installed to Platform 1 can easily be upgraded later to Platform 2 by installing a Lumi-LinQ Gateway*

# What Are The Benefits?



It can be time-consuming and costly to install additional low voltage data connections associated with day lighting systems. The TRT Lumi-LinQ lighting control system provides the option of full wireless control between Lumi-LinQ luminaires.

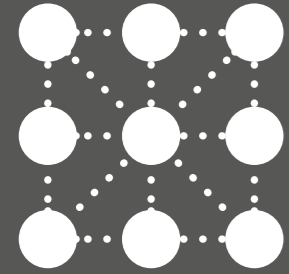

## System Flexibility

Lumi-LinQ utilises a wireless mesh network. Each device acts as a repeater, ensuring that data signals always find a suitable communication path. Groups are easily created and changed providing future flexibility without altering wiring.



## Excellent Wireless Reliability

An operational frequency of 868MHz provides excellent transmission distances and better penetration of signals.



## Efficient Communication

Intelligent algorithm with low transmission of data - transmits less than 1% of total time (99% of time wireless is off) - reduces wireless traffic increasing reliability.



## Intelligent Connectivity

Software uses simple wait before transmit logic to ensure error free transmissions.



## Reduced Installation Costs

The Lumi-LinQ Gateway and compatible Lumi-LinQ luminaires and Lumi-LinQ emergency luminaires simply require a mains connection.

All communication cables are replaced by the mesh network so there is no need for data cables, additional power supplies or control modules.



## Simple and Fast Commissioning

Using a single robust hand held infra-red programmer luminaires can be very quickly and easily commissioned, and all operational settings can be fine tuned in the future if desired.



## Made in Britain

Customer assurance that the system and luminaires are fully compatible - designed and manufactured by TRT in Britain.

Platform 2

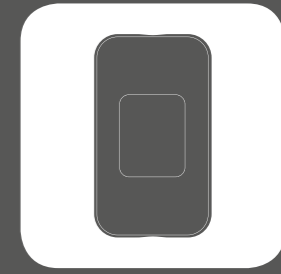

## Powerful Information Collection

The Lumi-LinQ Gateway uses the mesh network to communicate with individual luminaires, controlling emergency light test timing and obtaining information on energy usage and luminaire status.

This information is transmitted to the world wide web for viewing using tablets, smart phones, laptops and computers.



- 1 Lumi-LinQ luminaires wirelessly communicate with each other and the Gateway through the mesh network.
- 2 The Gateway transmits energy performance and status reports for both standard and emergency luminaires to the Lumi-LinQ web server.
- 3 Users employ their chosen device to view system information.

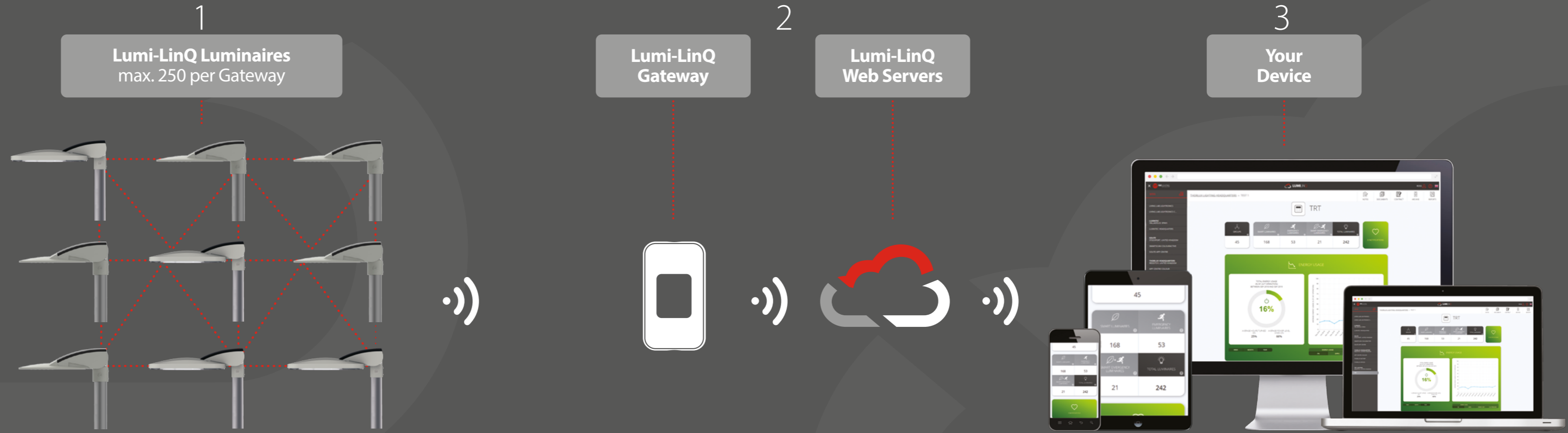

# Full Luminaire Status Monitoring



The Lumi-LinQ Gateway provides daily uploads of the system status to the website. Secure access allows the user to view full luminaire status monitoring, from the whole installation to individual groups of luminaires or even individual control gear items within a luminaire.

The website provides an easy to read visual reference highlighting the following:

## Lumi-LinQ Luminaires

- Mains control gear functionality
- Light source functionality
- Thermal performance (the luminaire is operating within correct temperature limits)
- Average energy used by the luminaire
- Total hours powered and operating/on

## Lumi-LinQ Emergency Luminaires

- LEDs status in emergency operation
- Number of hours that the LEDs have operated from the battery
- Integral battery is connected and charging
- Result of the last monthly function test and the date of the next scheduled test
- Result of the last annual duration test and the date of the next scheduled test
- Emergency lighting testing schedules are configured via the website



A full history of test reports is also available to view.

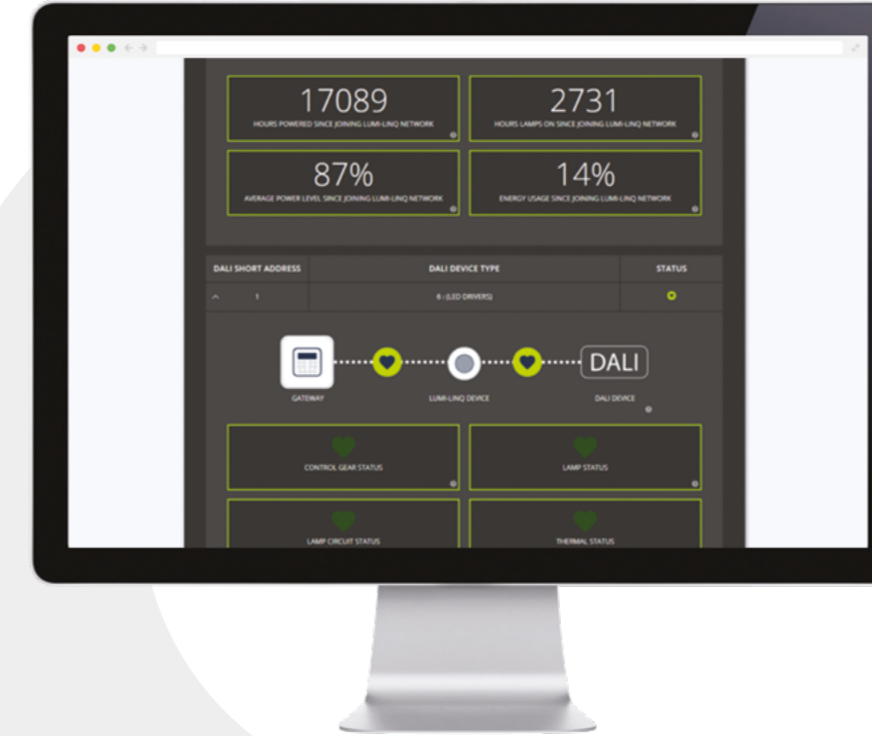

**Lumi-LinQ  
Status Reporting**



**Lumi-LinQ Emergency  
Status Reporting**

# Lumi-LinQ Emergency



Legally, BS EN 50172 requires each luminaire to complete a function test once a month and a full three-hour duration test once a year. Performing this process manually requires someone to be present to ensure that the luminaire stays lit for the duration of the tests, a time consuming and costly process, especially on large sites. Lumi-LinQ incorporates an emergency lighting system with centralised testing and reporting options. By automating the testing process, the time taken for inspection is eliminated significantly reducing costs.

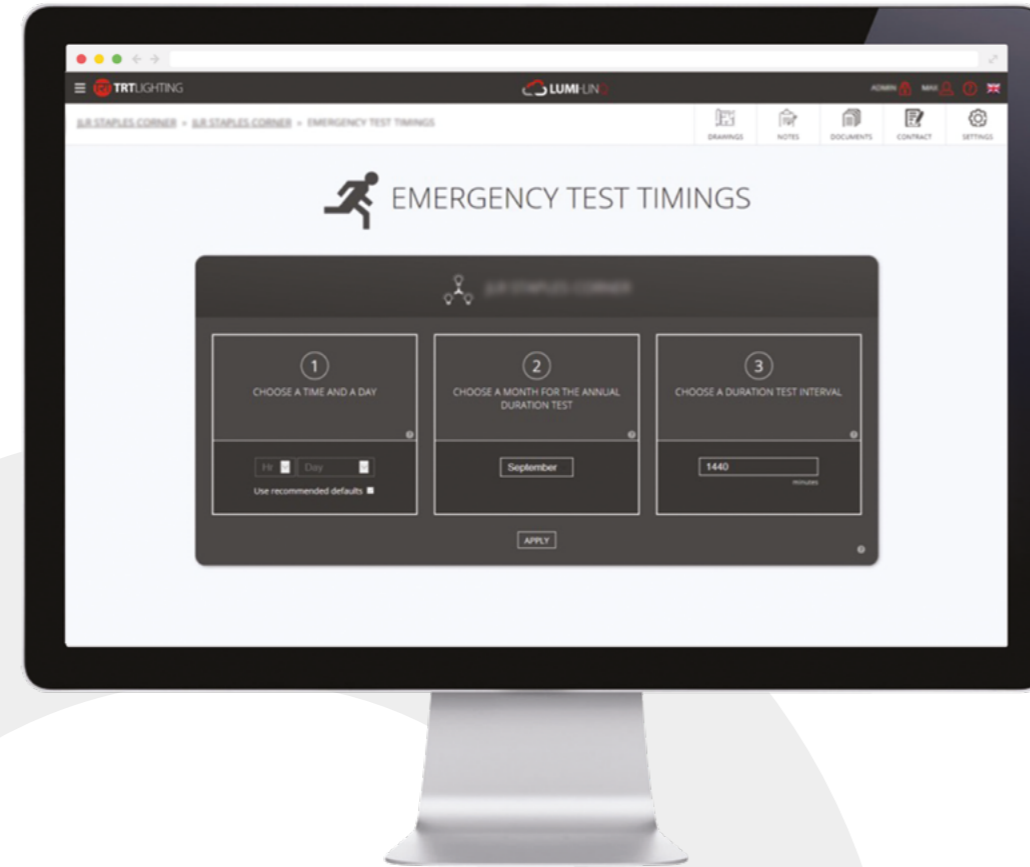

## Platform 1

At Platform 1 all Lumi-LinQ emergency luminaires are stand-alone and each luminaire will self-test to the schedule specified in BS EN 50172:2004. The operational status of each luminaire is displayed by the status LED and operational status information can be retrieved using the Lumi-LinQ Programmer. Manual tests can also be initiated at each luminaire using the Lumi-LinQ Programmer. The user, legally, will need to inspect each luminaire at prescribed intervals to monitor test status and manually log the results.

## Platform 2

At Platform 2, all luminaires are monitored by a central Gateway. The Lumi-LinQ Gateway provides daily uploads of the system status to the website. Secure access allows the user to view full luminaire status monitoring, down to individual control gear items within a luminaire.

The website provides an easy to read visual reference displaying the following for Lumi-LinQ Emergency Luminaires:

- LED status in emergency operation
- Number of hours that a LED has operated from the battery
- Integral battery is connected and charging
- Result of the last monthly function test and the date of the next scheduled test
- Result of the last annual duration test and the date of the next scheduled test
- Emergency lighting testing schedules are configured via the website

If a luminaire develops a fault or if communication is lost, then an error is indicated via the Lumi-LinQ website. The integral e-mail facility is completely pro-active and keeps the user informed of system status.

# Typical Lumi-LinQ External Lighting Application



## Times can be set on the Lumi-LinQ website

External lighting can be used in a number of ways, so flexibility of control is required. ON and OFF times can be set on the Lumi-LinQ website. Lumi-LinQ External groups can be configured in three ways:

- Presence detector control (default setting)
- ON between set times
- OFF between set times

In all three scenarios, the integral light sensor ensures luminaires are OFF if there is sufficient daylight.

## Lumi-LinQ Time Control

In the example below, timings are set to turn the luminaires ON between 17:00 and 20:00, and OFF between 00:00 and 06:00 the following morning. Automatic presence control (with light sensor override) is enabled outside of these times.

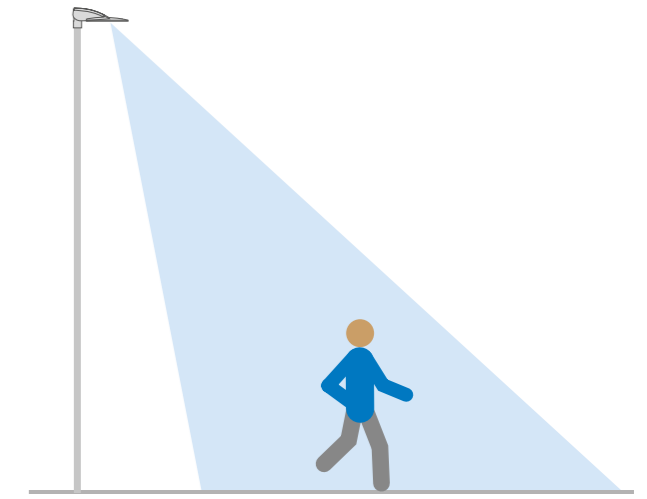
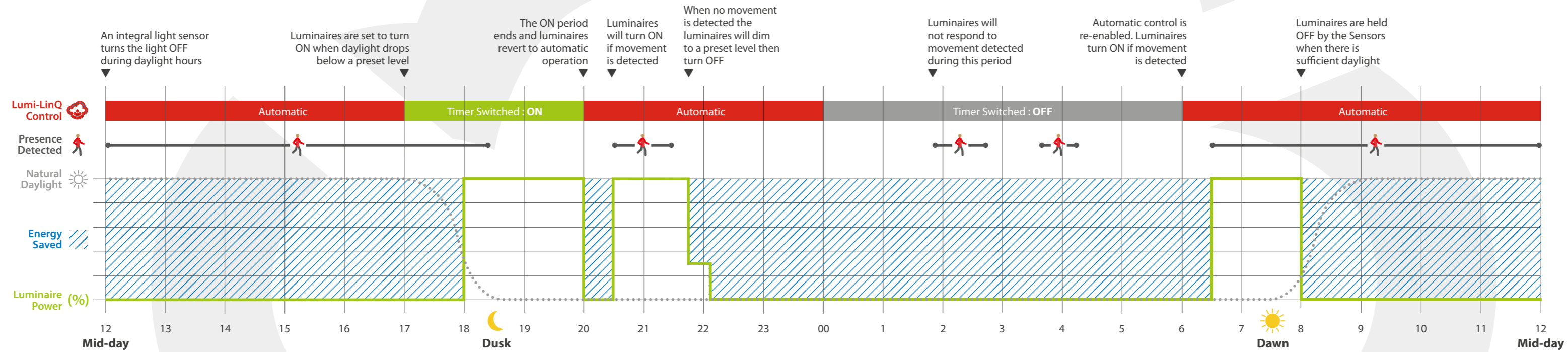

# Energy Usage Monitoring



Lighting accounts for approximately one fifth of the planet's electrical energy usage, therefore installing intelligent lighting controls can result in large savings. However, installing equipment to monitor this load can be expensive.

Lumi-LinQ luminaires have in-built energy usage monitoring capability.



## Lumi-LinQ - Platform 1

Monitoring information can be read back from each luminaire independently using the Lumi-LinQ programmer providing valuable maintenance and energy usage data.

## Power Monitoring Capability

Lumi-LinQ sensors monitor and record certain operating parameters which can be retrieved for analysis to provide maintenance and energy usage information. The Lumi-LinQ System will provide data for individual luminaires.

**Non resettable** Total time connected to mains (hours)

**Resettable \*** Time connected to mains (hours)  
Lamp switched on time (hours)  
Lamp on average power level (%)

\* 4300 hours maximum recording time (lamp on)



## Lumi-LinQ - Platform 2

Lumi-LinQ Platform 2 users have instant access to energy performance data via the Lumi-LinQ website.

The main screen for the site provides a graphical overview of energy use for all luminaires as a percentage when compared with a fixed output installation operating 24 hours a day 7 days a week. The user can choose to change this to kWh, energy cost or CO2 emissions, with an option to change the analysis period from the last week, to the last month or the last year.

It is possible to analyse this information further, as a group is selected this graph will update accordingly, with the ability to monitor individual luminaires if desired.

## USER FRIENDLY

The system is accessed using a web browser, there is no need for a specific app or piece of software.

## ENERGY DATA DOWNLOAD

The Export feature facilitates download of the basic energy data for any specified period of time as a CSV file. This can be imported into a spreadsheet for analysis.

## OFF-SITE STORAGE

Energy performance data, luminaire status, emergency lighting testing records, "as fitted" drawings, commissioning certificates and all the essential emergency lighting documentation is stored securely on the web server. Only authorised users have access to this data.

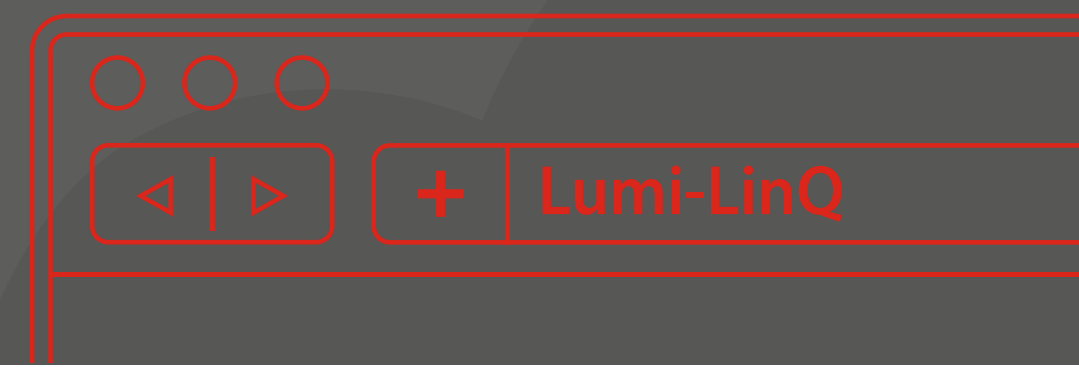





# Interactive Drawings



Lumi-LinQ Interactive Drawings provide a simple and effective method of viewing system information.

## Navigation

Each dataset is shown as a layer allowing the user to zoom in or out as needed.



## Information Table

If a single luminaire is selected, an information table is displayed with the data for that luminaire. The user can select a date, then using the time slider can see how the performance changes through the day.



## Status

The exact position of a luminaire is highlighted on the Interactive Drawing if it requires attention. The Information table will show the status of electronic components within the luminaire.



## Energy Savings

Daily energy savings are shown by a graduated indicator – the darker the green, the greater the energy saving that day. If a single luminaire is selected, the information table shows the energy performance for that luminaire.

# Energy Saving



LIGHTING FROM LUMINAIRES ENERGY SAVED

## PRESENCE DETECTION

Passive Infra-Red (PIR) sensors are used to detect movement to turn the luminaires on. After a predetermined time of no movement the luminaires will turn off, saving energy.

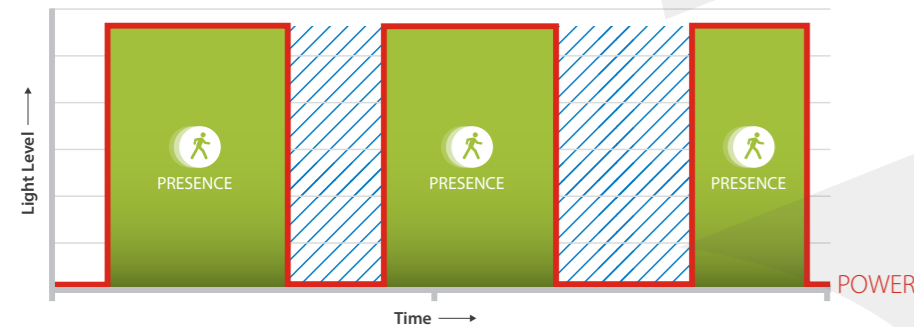

## PHOTOCELL CONTROL

The Lumi-LinQ Sensor incorporates an ambient light sensor which will enable at dusk and disable at dawn. The luminaire will remain off until movement is detected.

Ambient light level switching can be adjusted using the Lumi-LinQ Programmer.

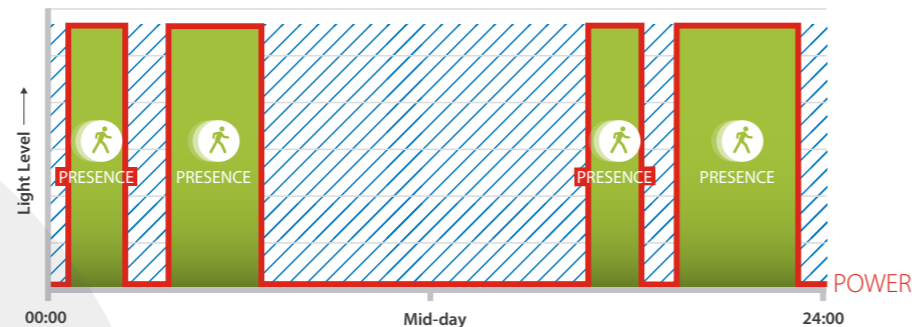

Automatic control can be overridden via the Lumi-LinQ website.

EXTERNAL TIME CONTROL >



# Lumi-LinQ Presence Detection

## MOTIONLINE

Lumi-LinQ luminaires utilise a wireless mesh network to form Motionline groups. This ensures effective group control and extends presence detection coverage.

## MOUNTING HEIGHT

The Lumi-LinQ sensor can be used up to 8m.

As mounting height increases so does the amount of movement needed to trigger the sensor.

## POSITIONING OF THE SENSOR

Where possible, TRT suggests Lumi-LinQ luminaires should be positioned in such a way that detection areas overlap. A Lumi-LinQ sensor is integrated into each luminaire ensuring that the optimum detection level is achieved with conventional spacing.

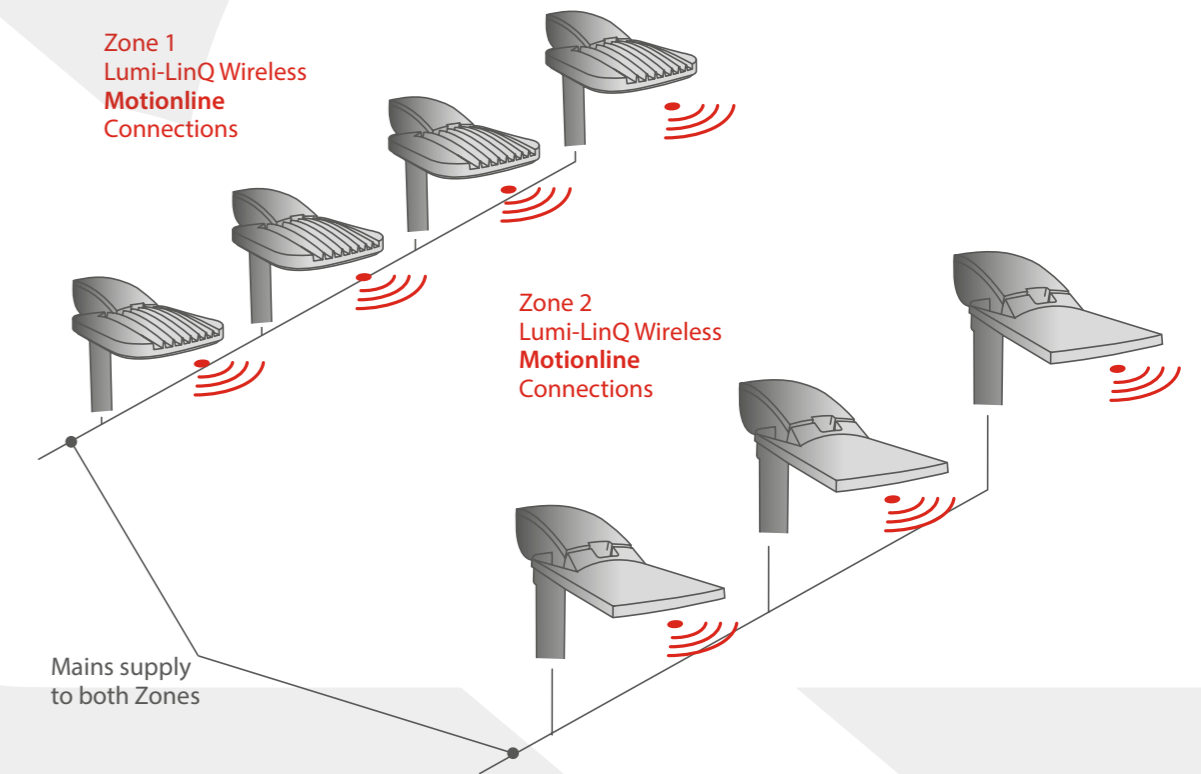

# Lumi-LinQ Sensor - Mounting height up to 8m



Optional shrouds can be fitted to the sensor to restrict the detection area if required.



No Shroud



ECO 17622



ECO 17620

## Lumi-LinQ Sensor Detection Area - 28°

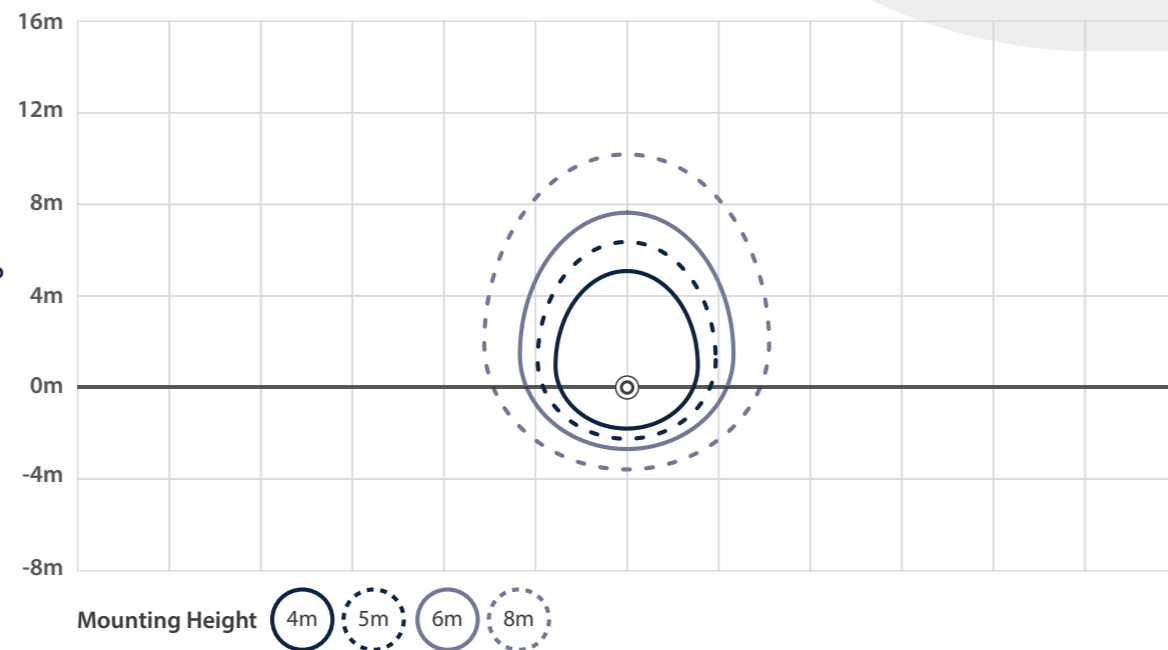
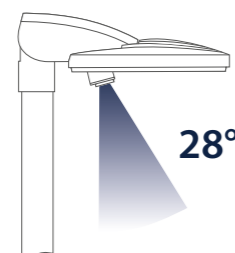

### NOTE:

The detection areas above detail maximum values.

For best presence detection it is recommended that luminaires are grouped using Motionline, which can be done without the need for any cabling due to the Lumi-LinQ wireless Motionline. The Lumi-LinQ control system with the addition of a Lumi-LinQ Gateway allows users to set operational times of Lumi-LinQ luminaires.



## LUMI-LINQ SENSOR

The Lumi-LinQ sensor is designed to be used in applications of up to 8m.

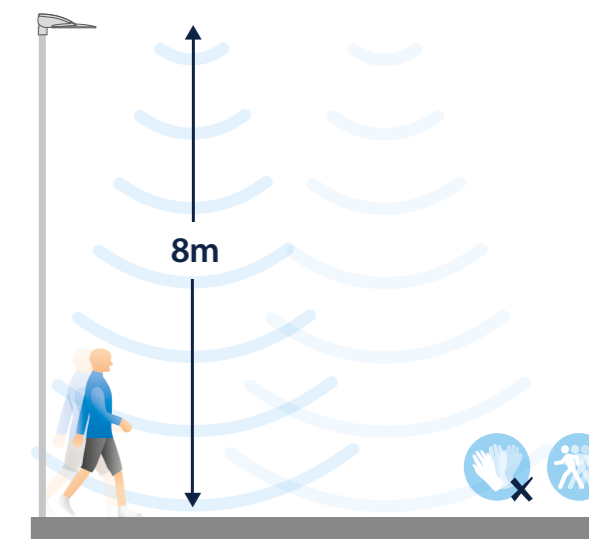

# Commissioning



## WHAT IS COMMISSIONING?

TRT offers a professional on-site commissioning service to ensure that products are configured to provide the desired performance and return on investment. Commissioning begins with identifying the end-user's project requirements and ends with ensuring that the installed systems satisfy these requirements. After all, the end user has paid extra for electronic systems to offer benefits – it's important that these benefits are realised.

## DEFAULT FACTORY SETTINGS

A common misconception is that default factory settings will provide the desired energy savings and performance. All Lumi-LinQ luminaires leave the factory with default settings that will turn the lights on and off as required. However, these default factory settings do not take into account site-specific conditions. Conditions can vary widely from installation to installation, it is impossible to optimise settings in the factory. In addition, luminaire positions and mounting heights can dramatically affect the overall performance of the system. Some end users may also choose specific settings.

## IDENTIFYING END-USER REQUIREMENTS

The end user's requirements are agreed prior to TRT's site visit; typically the end user or design team provides TRT with a clear expression of expectations. TRT prepares a pre-commissioning checklist to document the agreement. The checklist includes information about the tasks being conducted on site, special needs, light levels, visual comfort, energy efficiency, maintenance, applicable codes and standards and many other issues. The customer-specific requirements are highlighted on the TRT commissioning certificate. This formal document provides a clear, detailed description of the requirements addressed during configuration, and may include other helpful information such as details of performance testing and

acceptance criteria, requested deviations from standard BS/EN/CIBSE requirements, control zoning and references to related documents such as wiring diagrams.

## COMMISSIONING LUMI-LINQ LUMINAIRES

All Lumi-LinQ luminaires offer a number of parameters that can be altered to suit the site and user requirements:

**Light level:** Lumi-LinQ luminaires need to be set to maintain the correct illumination level.

**Time-out periods:** The default setting of 10 minutes before the luminaires turn off is suitable for many applications, but it can be adjusted.

**Security level:** In some applications (such as school car parks), the luminaires are set to dim to a lower output level rather than turning off at the end of the time-out period. This offers a feeling of increased security for users.

## ADDITIONAL LUMI-LINQ COMMISSIONING REQUIREMENTS

All Lumi-LinQ luminaires are delivered with wireless communications disabled to avoid problems during installation. Therefore all installations must be commissioned to configure luminaire addresses and enable wireless communications which are essential for reliable and correct operation. Lumi-LinQ platform 2 projects need additional commissioning procedures, which can only be undertaken by TRT's commissioning engineers. These include:

- Communications between the Gateway and Web server to enable website reporting of energy consumption and luminaire status
- Luminaire data input for correct energy reporting
- Assignment of Gateways to end-user companies
- Marked up drawings with luminaire location details
- Web access and email configuration for authorised users

## USER TRAINING

During, or after, handover of the lighting systems to the client, TRT can train facility personnel on the operation and maintenance of the lighting and the control system. Trained staff who fully understand the controls are less likely to attempt to override or bypass the system.

## BENEFITS OF COMMISSIONING

Energy and operating costs are reduced as a result of fine-tuning. The cost benefits of commissioning continue for many years, whereas implementing the commissioning process is a one-time cost.



# Programming

**Each Lumi-LinQ luminaire can be individually programmed ensuring that the lighting installation is tailored not only to meet the needs of the users but to also maximise energy savings.**

**The lighting system can be fine-tuned by using a Programmer to read the settings from a luminaire, make adjustments, and transmit back to the luminaire.**

Factory default settings can be adjusted when required, so the lighting may be reconfigured if the use of an area changes.

Whilst the TRT Lumi-LinQ control system is designed to operate with factory default settings "straight from the box" TRT strongly recommends on site commissioning to ensure optimum energy saving and user convenience.

All Lumi-LinQ luminaires are delivered with wireless communications disabled to avoid problems during installation. Therefore, all Lumi-LinQ installations must be commissioned to configure luminaire addresses and enable wireless communications which are essential for reliable and correct operation.



# Lumi-LinQ Luminaires



## Lumi-LinQ Sensor

- Grouped presence or absence detection
- Individual maintained illuminance/daylight dimming and switching
- Individual manual dimming
- Scene setting
- Energy performance monitoring
- Full programmability
- Control gear status monitoring
- Integral emergency lighting test results

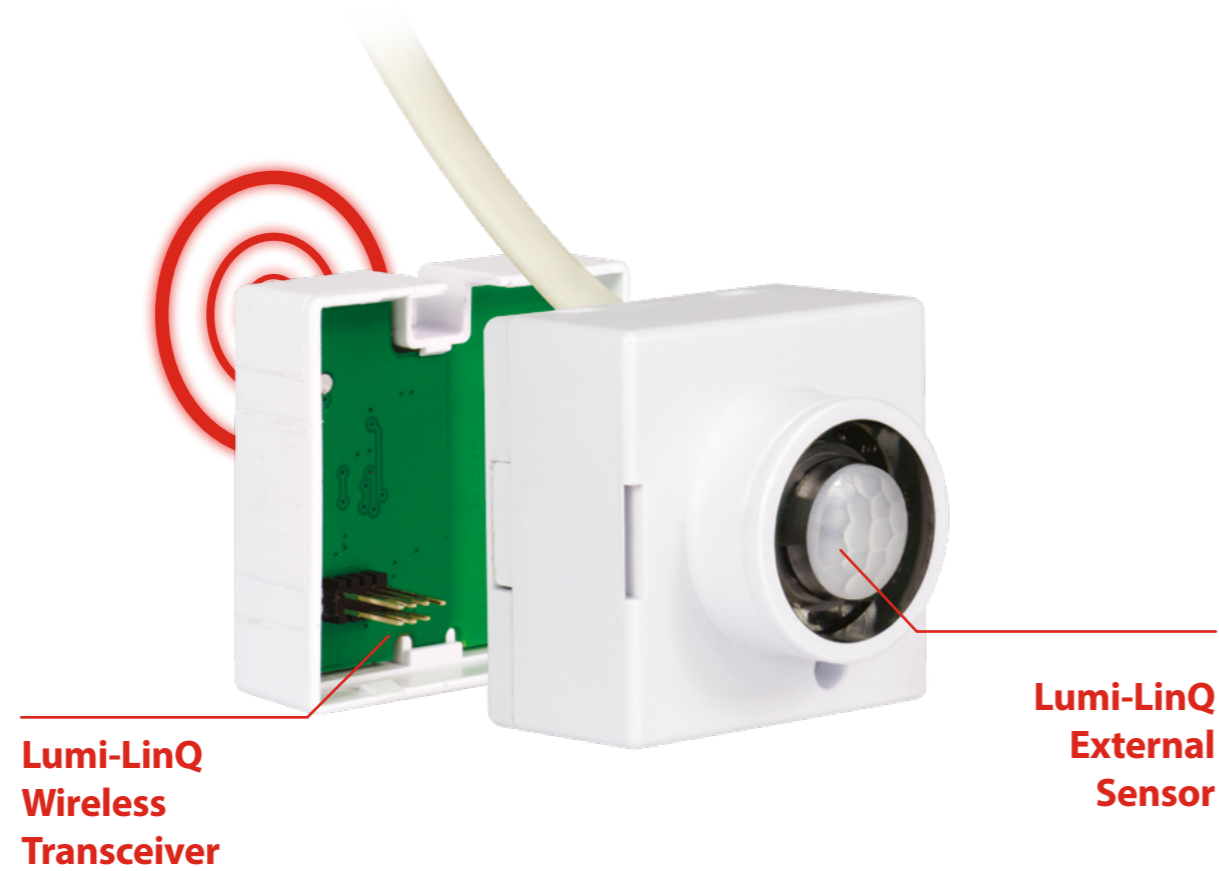

**Lumi-LinQ External Sensor**

**Lumi-LinQ Wireless Transceiver**



# Control Products



## Lumi-LinQ Gateway

- Monitors and controls up to 250 Lumi-LinQ luminaires. (More Gateways can be fitted on large installations)
- Transmits Lumi-LinQ energy performance and lighting status reports to the Lumi-LinQ web server
- Controls emergency lighting testing dates/times
- Controls external lighting switching times



## Lumi-LinQ Programmer

- Used for commissioning
- Simple and fast setting of operational parameters from ground level
- Protective silicone sleeve
- Laser pointer for accurate alignment
- Supplied with batteries fitted



## Lumi-LinQ External Stand Alone Sensor

- For areas where presence detection is required but a Lumi-LinQ luminaire is not conveniently situated e.g. escape exits etc.

# Lumi-LinQ Gateway



## RANGE

| DESCRIPTION       | APPROX. kg |
|-------------------|------------|
| Lumi-LinQ Gateway | 1.0        |

## DIMENSIONS

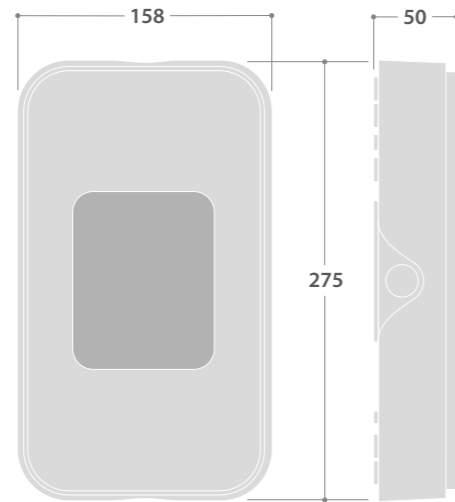

## MASTER CONTROL AND WEB INTERFACE WITH LUMI-LINQ WIRELESS COMMUNICATION



### SPECIFICATION

- Polycarbonate body finished white (RAL9016), silicone keypad
- Central control for up to 250 Lumi-LinQ Luminaires and emergency luminaires. Extra Gateways can be fitted to accommodate more luminaires
- Central control for multiple groups
- Allows user to manually initiate emergency lighting tests
- Password protected
- Communicates with the Lumi-LinQ website using GSM mobile telecommunications
- Scheduled test times / dates managed using the Lumi-LinQ website



# Lumi-LinQ Programmer

Simple and fast setting of operational parameters from ground level.



## DIMENSIONS



## RANGE

| DESCRIPTION          | APPROX. kg |
|----------------------|------------|
| Lumi-LinQ Programmer | 0.44       |





# Lumi-LinQ Specification

Each luminaire shall be equipped with an 'intelligent' electronic sensor providing movement detection, light level sensing and an infra-red transceiver for programming and remote control. Luminaires shall be capable of being linked together to form motion groups. Linking shall be possible using a two core bus or wirelessly using an 868 MHz transceiver. Movement detected by one sensor will be signalled to all other sensors in its group. No bus power supply or other ancillary control devices will be required to facilitate such operation.

Each sensor shall provide individual dimming of the luminaire and maintain a set illumination level. Sensors shall be fully programmable and reconfigurable using a hand held infra-red programmer. The programmer shall be capable of reading back and displaying current sensor settings and power/maintenance monitoring information from individual luminaires. Monitoring can be reset by the user. Sensors to be capable of operating DALI drivers. Emergency luminaires shall be self-test with built in wireless capability, operating on the same wireless network as the standard intelligent luminaires. Tests can be initiated using an infra-red programmer as well as retrieving emergency operational status information.

The system shall be monitored by a central wireless Gateway which will upload system status and energy performance to a website for users to view in a graphical format.

#### Wireless connectivity

Luminaires shall be capable of being inter-connected wirelessly. Operational frequency shall be 868 MHz with low data rates - less than 1%. The system shall work on a mesh networking principle and be capable of adding link addresses across a site. The link addressing shall be independent from the group addressing. Programmable settings can be altered from floor level using an infra-red programming device.

#### Emergency luminaires

Emergency luminaires shall be self-contained LED type, capable of communicating status via the wireless mesh network to the Gateway. System test times and other parameters shall be programmed via the website, this information shall be automatically downloaded to the Gateway. The Gateway shall control all emergency testing and reporting automatically.

#### Website system monitoring

All luminaires shall report status to the Gateway once per day. This will include failure status and energy performance data. These records shall be uploaded to a website periodically where the data will be stored securely and displayed in graphical format. The website will also store supporting site documentation including 'as fitted' drawings, commissioning certificates and any other documentation required by the end user.

#### Environmental credentials

The manufacturer shall be independently certified to ISO14001. The manufacturer's processes shall be carbon offset via a quantifiable carbon offsetting scheme and shall include emissions from the lighting manufacturer's vehicles used for delivery and other project associated mileage.

#### Short specification text

Intelligent luminaires to be fitted with integral Lumi-LinQ sensor providing presence detection. The system shall be capable of group presence communication ensuring luminaires can illuminate in groups and with individual scene setting control using 868 MHz wireless mesh connectivity with link address capability. All features are to be programmable from floor level using an infra-red remote control programmer. The system to provide daily maintenance status reports and energy performance data for viewing on remote website with the capability to store drawings and documentation.





TRT Lighting Ltd (Thorlux Road and Tunnel Lighting) is one of ten companies within the FW Thorpe Plc group, and evolved from parent company Thorlux Lighting. Building on more than 80 years of experience, TRT designs, manufactures and supplies energy efficient, environmentally friendly performance lighting products for the road, tunnel and exterior lighting markets

LED lighting solutions bring another dimension to how roads, tunnels and general exterior spaces are illuminated. At TRT, our ability to understand and adapt to our customers' needs ensures that we develop products that are technically and mechanically sound and provide energy efficient, long lasting lighting solutions with excellent returns on investment.

As well as being subjected to our own in house rigorous testing facilities, all of our products are externally third party tested and verified against all relevant global and regional standards and requirements.

We are proud to manufacture our products in Britain.

**TRT Lighting Ltd**  
Heming Point  
Claybrook Drive  
Washford Ind Est  
Redditch  
Worcestershire  
B98 0FH  
England

**T** +44 (0)1527 521 162  
**E** [info@trtlighting.co.uk](mailto:info@trtlighting.co.uk)  
**W** [www.trtlighting.co.uk](http://www.trtlighting.co.uk)

The information given in this catalogue is typical and must not be interpreted as a guarantee of individual product performance and/or characteristics. We reserve the right to alter specifications and designs without prior notice.

